



**Volodymyr Oliinyk,  
Mykhailo Babakov,  
Yurii Lomonosov,  
Viacheslav Oliinyk,  
Oleksandr Zinchenko**

## MODERNIZATION OF GAS DISCHARGE VISUALIZATION FOR APPLICATION IN MEDICAL DIAGNOSTICS

*The object of research is the processes of the emergence and glow of a discharge around biological structures in a pulsed electric field. Such processes have found use in the method of gas discharge visualization. In medical diagnostics, the general state of human health is assessed by the characteristics of gas-discharge images of fingers. One of the most problematic areas of the correctness of medical diagnostics is the dependence of the visual components of the image on the electrical characteristics of the discharge and the physical and chemical characteristics of the surrounding environment.*

*In the course of the study, methods of modeling the electric discharge current circuit and electrical properties of biostructures were used.*

*The proposed solution allows taking into account: the amplitude of the impulse voltage of the discharge, the frequency of the impulses, the duration and intensity of the impulses, the polarity, which act as additional diagnostic parameters of the gas-discharge visualization process. Physical processes are considered, and a model of a chain of gas discharge around a biological object in a pulsed electric field is proposed. It is shown that the occurrence of a discharge and the characteristics of the glow depend on the amplitude, duration, frequency, and polarity of the pulse voltage. These additional parameters determine the correctness of further visual diagnostics. Their quantitative measurement and the possibility of objective comparison should be attributed to the advantages of registering the proposed parameters of gas discharge visualization. The specified properties of these parameters provide an additional opportunity to digitally describe the condition of the object under study, and subsequently to automate diagnostics. The structural diagrams of the device for conducting research using the method of gas discharge visualization, the high-voltage impulse voltage generator unit for the hardware consideration of additional gas discharge parameters and their connection with medical and biological indicators have been developed.*

*The use of the method and means of gas discharge visualization to assess the functional state of the flight crew in the pre- and post-flight period requires the development of special equipment. The proposed technical solutions require experimental verification. Comparative studies of diagnostic conclusions by the method of gas-discharge visualization with traditional medical diagnostics are necessary.*

**Keywords:** biological object, gas discharge, visualization, electric discharge circuit model, structural diagram, gas-discharge sensor.

Received date: 01.07.2022

Accepted date: 19.08.2022

Published date: 29.08.2022

© The Author(s) 2022

This is an open access article

under the Creative Commons CC BY license

### How to cite

Oliinyk, V., Babakov, M., Lomonosov, Y., Oliinyk, V., Zinchenko, O. (2022). Modernization of gas discharge visualization for application in medical diagnostics. *Technology Audit and Production Reserves*, 4 (1 (66)), 21–29. doi: <http://doi.org/10.15587/2706-5448.2022.263397>

### 1. Introduction

Aviation and space medicine studies the conditions of professional activity of aircraft crew members and specialists providing flights in order to develop medical recommendations aimed at maintaining health and improving their performance, as well as ensuring flight safety. One of the main scientific and practical tasks of aviation and space medicine is the medical control of the crew of aircraft before flight, flight and after flight. Traditional control requires examination by doctors of all specialties and a lot of laboratory tests. An alternative to such time-consuming

and routine studies can be integrated methods for diagnosing the state of the human body. Such methods provide a comprehensive assessment of the functional state of a person. This makes it possible to speed up the process of conducting a medical examination of the flight crew and to localize the area of deviation in the values of medical and biological indicators, which can be diagnosed by more accurate specialized research methods.

One of the promising methods for a comprehensive assessment of the functional state of the flight crew is the method of gas discharge visualization (GDV) [1]. Diagnostics is carried out according to the characteristics of the

glow that occurs when the fingers or limbs of the test person are placed in a pulsed electric field (Kirlian effect) [2]. But the possibility of using the method and means of GDV in practical aviation medicine requires additional research and modernization of the hardware component.

## **2. The object of research and its technological audit**

The physical basis of medical diagnostics by the method of gas-discharge visualization is radiation in the optical visible range. The characteristics of this radiation, in most cases, in the fingers are converted flat images used as diagnostic indicators [3].

One of the most problematic areas of the correctness of medical GDV diagnostics is the dependence of the visual components of the image on the electrical characteristics of the discharge and the physical and chemical characteristics of the environment. In accordance with this, the object of study was also determined.

*The object of research* is the processes of the emergence and glow of the discharge around biological structures in a pulsed electric field.

The use of a pulsed electric field of sufficient intensity for the occurrence of a discharge makes it possible to build hardware that is convenient for general diagnostics of the patient's condition.

The following advantages of using the GDV method in medical practice are distinguished:

- the possibility of screening and monitoring the whole organism and its individual systems;
- non-invasiveness, safety and complete sterility, removal of information only from the patient's limbs;
- the ability to follow the development of processes in time, the comparison of structural, functional and temporal processes in the body;
- methodological simplicity and convenience: the absence of any special requirements for the premises, environmental conditions [3].

The disadvantages of the method include the variability of images depending on the conditions of the discharge. Therefore, this work is devoted to the selection and justification of additional quantitative parameters of the gas-discharge visualization process, the development of the hardware structure of the gas-discharge diagnostics device, and in particular the block of a controlled source of high-voltage pulsed voltage.

## **3. The aim and objectives of research**

*The aim of research* is to increase the reliability and information content of gas discharge visualization medical diagnostic tools by recording the conditions for the appearance of an image.

To achieve the aim, the following objectives were set:

1. Analyze the features of the occurrence of electrical discharges used in the method of gas-discharge visualization.
2. Build a model of electrical circuits of gas-discharge processes.
3. Determine additional quantitative parameters of the gas-discharge visualization process associated with the properties of a biological object.
4. Develop the structure of the device for conducting GDV studies with the registration of additional parameters.

## **4. Research of existing solutions to the problem**

**4.1. Fundamentals of the gas discharge visualization method.** The method of gas discharge visualization (GDV) refers to bioelectrographic methods for studying the psychophysiological and functional state of a person [1]. The method is based on the Kirlian effect.

The Kirlian effect is visual observation or registration on photographic material of the radiation of a gas discharge that occurs near the surface of the object under study (aura) when the latter is located in a high-strength electric field [1, 4]. This effect was discovered by the Kirlian in the 1950s. Their studies have shown that the type of kirlianograms (the image of the radiation of a gas discharge near the surface of the studied biological object, in particular the fingers of a person) changes with a change in the state of a person.

With all the abundance of specific technical solutions, the essence of the visualization process can be reduced to a certain theoretical scheme. The initial process is the interaction of the electromagnetic field (EMF) with the object of study, as a result of which, at certain electric field strength, there is an emission of charged particles from the surface of the object involved in the initiation of the initial phases of the gas discharge. The gas discharge, in turn, can affect the state of the object, causing secondary emission, destructive and thermal processes. Thus, in the process of gas-discharge visualization, a certain sequence of information transformations is formed:

- the state of a biological object (BO), characterized by physiological processes and medical and biological indicators, among which the determining role in terms of the GDV process is played by physicochemical and emission processes;
- gas separation processes depending on changes in the impedance of the object as a whole, the impedance of its surface areas, their structural and emission properties [2, 4].

Changes in the latter parameters are actively manifested on the skin due to reflexogenic zones and biologically active points. The inhomogeneity of the surface and volume, the processes of emission of charged particles or the release of gases affect the parameters of the electromagnetic field, due to which the parameters of the gas discharge change. These parameters are the characteristics of the discharge current and optical radiation. In this case, the main information is obtained from the characteristics of the radiation, which is a spatially distributed group of areas of different brightness. The radiation receiver converts the spatial distribution of brightness into an image, and analysis of the amplitude characteristics of the video signal leads to the formation of a set of parameters. A symptom complex is built from the parameters, on the basis of which the doctor forms a medical diagnosis.

In the GDV process, due to the action of an alternating electric field and the occurrence of a gas discharge, information on the characteristics of a gas discharge image is converted into information on the characteristics of the object under study.

In this case, the biological object is a part of the electric circuit, a current flows through it (it is extremely small so as not to cause its own reaction of the BO).

The resulting image (aura, it is also often called a GDV-gram, by analogy with a cardiogram, an encephalogram, etc.)

carries generalized (integral) information about the state of the BO. In medical diagnostics, as a rule, GDV-grams of the fingers are taken as the object of research.

The GDV method has always attracted the most attention due to its diagnostic capabilities. Therefore, until now, the main direction of the implementation of the method has been the issues of preventive diagnostics [5, 6].

The following advantages of using the GDV method in medical practice can be singled out [7]:

- the possibility of screening and monitoring the entropy-energy homeostasis of the whole organism and its individual systems;
- objectivity of information: independence from the desire and experience of a particular user;
- non-invasiveness, safety and complete sterility, removal of information only from the patient's limbs;
- the ability to follow the development of processes in time, the comparison of structural, functional and temporal processes in the body;
- methodological simplicity and convenience: the absence of any special requirements for the premises, environmental conditions;
- the use of modern methods of nonlinear mathematics for processing fractal images and selecting information about the patient's condition;
- visibility and the possibility of interpreting the results, the convenience of their storage and processing.

#### 4.2. Hardware component of GDV for medical diagnostics.

The hardware implementation of the GDV is as follows: between the transparent electrode and the object under study placed on it, electrical impulses are applied from a high-voltage generator [1, 7]. At a high intensity of the electromagnetic field in a gaseous medium, a gas discharge develops around the object and the transparent electrode, the parameters of which are determined by the properties of the object.

An image of a gas discharge is formed using a matrix based on charge-coupled devices (video camera or camera) and is digitally transferred to a computer with appropriate software for further processing [3].

The processed GDV-gram (discharge snapshot) makes it possible to analyze a number of parameters that reflect the state of the object and draw certain diagnostic conclusions based on them. The most important parameters are the intensity, perimeter, and area of the glow image in each sector [2]. An example of GDV-grams of a finger of a healthy person and a finger of a person with chronic inflammation are shown in Fig. 1.

Fig. 1 clearly shows the possible differences between the images of the discharges of healthy and unhealthy people.

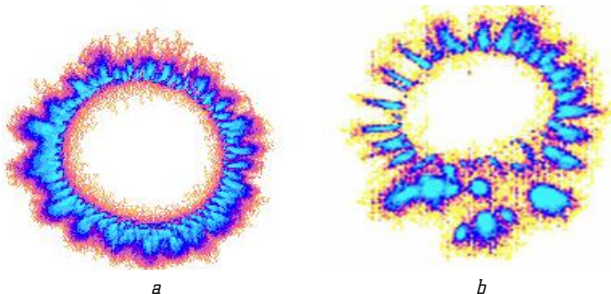

Fig. 1. GDV-grams of thumbs:

*a* – healthy person; *b* – a person with chronic inflammation

The principles developed on the basis of the studied physical processes were implemented in software and hardware GDV complexes [3, 5]. A high-performance RISC microcontroller allows controlling the device and selecting operating parameters from an auxiliary computer, synchronizing the operation of all units, and also configuring the device parameters for self-control. The microcontroller controls the main power supply and switching regulator, the voltage from which is supplied to the high-voltage pulse generation unit. A programmable video signal recording delay with respect to the applied voltage pulse allows tracking the dynamics of the response of a biological object to an excitation pulse.

In [7], the following parameters are given for the standard implementation of the device:

- amplitude of bipolar impulses from 3 to 20 kV with continuous or step adjustment;
- pulse duration 10 microseconds;
- pulse frequency up to 1000 Hz;
- setting the exposure time in the range from 0.1 to 32 s;
- implementation of two-way communication with a computer via a USB port, which allows both transferring information (commands) to the device and diagnosing the operating modes of the device;
- quartz stabilization of all parameters with an accuracy of no worse than 1 %;
- operates both from a 12 V direct current source and from a 110–220 V alternating current network based on pulse stabilization circuits.

The list of these parameters and their quantitative values are consistent with the data of patents on the GDV device [8, 9].

GDV equipment, which has become widespread in medical practice, includes a line of GDV devices [2, 3], their main technical characteristics are given in Table 1. Auxiliary tools for the study of environmental objects are also produced, which are included in the set of «GDV minilaboratories». The device «GDV Express» is designed for simultaneous removal of GDV-grams of ten fingers of a person.





It follows from the available information that the frequency of the pulsed voltage is chosen unchanged and is 1 kHz with a duration of 10  $\mu$ s. How the required pulse amplitude is set for the occurrence of gas-discharge visualization is not specified. In [9], a reference object is used to check the operating state of the device. When the image characteristics deviate, the parameters of the impulse voltage change within 10 %, but they are not recorded as additional information indicators.

Other changes in the GDV tools are reflected in [10], where single-channel technical solutions were developed, extended to a multi-channel device (for example, GDV Express). In [11], GDV device is used as a component of the resonant wave diagnostics system. These imaging modes use pulse voltages of 3.5–25 kV, frequency 4–120 kHz and duration 0.5–0.6 s. The conditions for using specific values of these parameters are not explained.

The paper [12] proposes the structure of a device for expanding the diagnostic properties of GDV diagnostics. The discharge supply unit generates rectangular bipolar pulses with voltage up to 15 kV. The pulse frequency is adjustable from 1–200 kHz, and the intensity is adjustable from 5–95 %. How the discharge parameters are chosen and whether they are classified as informational is not indicated in the work.

**Table 1**

Comparative characteristics of GDV devices

	GDV Mini	GDV Compact	GDV Camera	GDV Express
Functions and characteristics				
Human diagnostics	1 finger	1 finger	1 finger	10 fingers at the same time
Substance research	No	Water only (using accessory)	Some substances (using GDV Mini Lab)	There is not
Number of voltage modes	1	1	4	1
Voltage amplitude, kV	Information is absent	Up to 5	Up to 5	Information is absent
Single pulse duration, $\mu$ s	Information is absent	Information is absent	10	Information is absent
Pulse train frequency, Hz	Information is absent	1024	900–1100	Information is absent
Duration of automatic exposure, s	Information is absent	Information is absent	0.5/1.0/2.0/32	Information is absent
Input signal to automatic processing device	Information is absent	Information is absent	Digital video signal in CYX 4:2:1 standard	Information is absent

Directions for the use of hardware and software systems of the «GDV Camera» type for applied tasks of medical diagnostics, including the assessment of the psycho-emotional state of a person, are presented in [13]. The effectiveness of using entropy indicators of GDV image analysis for biometric identification of a wide range of diseases is presented in [14], but without detailing the technical means used.

Scientific publications of the last decade, related to the methods and means of gas discharge imaging, have been focused on the possibility of their application in medical diagnostics. The authors of [15] studied the influence of the energy state of a person on the structure of water samples using the GDV method. The work [16] proved a high correlation of diagnostic parameters of GDV with the indicators of ECG, EEG and acupuncture diagnostics. The studies were performed using the GDV Chamber device.

Review publications [5, 6] provide examples of the use of GDV diagnostics in both classical and non-traditional types of medicine: homeotherapy, yoga therapy, music therapy, and others.

Thus, the results of the analysis allow concluding that the method of gas-discharge visualization essentially allows reducing the time for diagnosing the functional state and the presence of possible pathologies in humans, other biological objects or their parts.

However, it should be noted that:

- the hardware for implementing the GDV method has a branched nomenclature with disparate technical characteristics, which makes it difficult to correctly compare the diagnostic results;
- the diagnostic result is based solely on the interpretation of the brightness of the flat projection of the gas discharge glow around the object;
- visualization of images depends on the conditions for the occurrence of the discharge;
- an insufficient number of comparisons of the results of ORV diagnostics with the results obtained using methods recognized in medical practice.

Thus, it is necessary to analyze the features of the occurrence of electrical discharges used in the method of gas-discharge visualization.

## 5. Methods of research

In the case of GDV imaging, avalanche and sliding discharges are used, which are varieties of spark [4, 17]. They are formed when one electrode, for example, a rod, rests its end on a dielectric plate, and the other electrode is a metal lining on its other side. The branched discharge channels in the gas, pressing against the dielectric, scatter from the rod and flow around the plate until they are deposited on the other side. A branched trace remains on the plate, caused by deformations of the material under the action of temperature and pressure in the spark channels, should be visualized; these paintings are called Lichtenberg figures. The nature of the pattern depends on the polarity of the rod, and the dimensions on the value of the electrical voltage used to study lightning discharges.

A sliding discharge occurs when the voltage on the surface of a thin-layer dielectric increases rapidly, when its other side is covered with a conductive layer. With a large steepness of the rise in the electric potential, high electric field strength is maintained due to the small thickness of the dielectric [1]. Structural elements of the device for providing this type of discharge are shown in Fig. 2.

If the amplitude of the voltage pulses or the gas pressure is gradually increased, then at a certain value from the discharge figure described above, an intense streamer develops: the next (streamer) stage of the discharge begins, which then passes into a spark. Strong currents of the order of  $10^3$ – $10^4$  A flow through the formed spark channel due to a voltage drop across the external resistance or as a result of the rapid discharge of the capacitor. This causes intense release of «Joule heat».

As can be seen from the data, the values of currents and intensities in the channels of the streamer and leader stages of the discharge are 5–6 orders of magnitude higher than the intensities and currents in biological objects. Therefore, with GDV of biological objects, one should mainly use the initial (avalanche and the beginning of the streamer) stages, since only they contain information about the emission processes on the surface of the biological object, which have a significant effect on the type of discharge in these stages. The integral value of the current

for the GDV in a pulse does not exceed 50 mA [18, 19], and the current through the object under study is 1.5 mA.

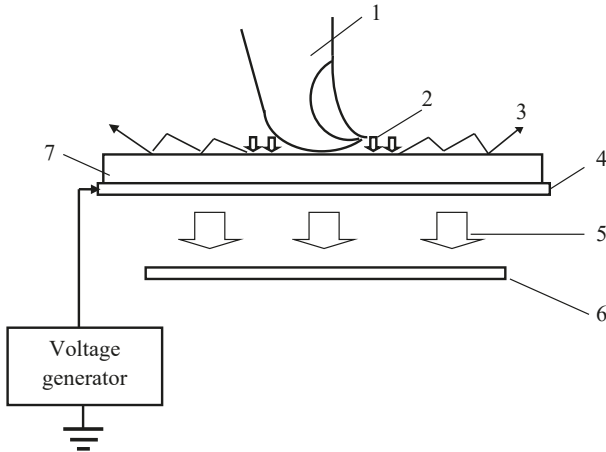

**Fig. 2.** The structure of the elements to ensure the GDV process:  
1 – object of biological origin; 2 – avalanche breakdown; 3 – sliding discharge; 4 – transparent conductive film; 5 – glow in the optical range of radiation; 6 – photosensitive element; 7 – transparent dielectric plate

Thus, when a biological object (BO) is introduced into a high-frequency ( $f > 1$  kHz) electric field with a high intensity (up to 20–25 kV/cm), a characteristic glow similar to a corona discharge is observed around the object [1, 2]. The color of this glow is directly related to the chemical composition of the gas in which the object is located, and other characteristics (first of all, the spatial form of the glow and the discharge current) depend on the nature and state of the BO itself. This glow is often called the «aura» of a biological object, and in science this phenomenon has been given the name «Kirlian effect» – in honor of S. Kirlian, one of the first researchers of this effect [1].

## 6. Research results

### 6.1. Model of electrical circuits of gas-discharge processes and selection of additional visualization parameters.

With a gas discharge in atmospheric air, the biological object under study becomes a link included in the electric current circuit. In view of the fact that at frequencies of electrical processes up to 1–10 MHz, the electrical properties of biological tissues are determined mainly by resistive and capacitive properties, RC elements can be included in the model of this link [19].

Other structural elements of the GDV process support are also modeled by the scheme of connected RC circuits. Changes in the complex resistance of the BO due to physical and physiological processes lead to a redistribution of currents in the circuits and a change in the parameters of the gas discharge. To analyze the discharge processes, an equivalent circuit is proposed, shown in Fig. 3.

On the diagram of Fig. 3, let's select two RC circuits I and II connected in series. The properties of the first circuit depend on the properties of the dielectric plate (most often glass). For example, if other parameters are constant, the length of the discharge track and the voltage of transition to the streamer stage are inversely proportional to the square root of the specific surface capacitance [20]:

$$U_{str} = \frac{1}{\sqrt{C}}, \quad (1)$$

where  $C = k\varepsilon/\delta$ ;  $k$  – coefficient taking into account physical steels and design features;  $\varepsilon$  is the relative permittivity of the transparent plate;  $\delta$  – plate thickness.

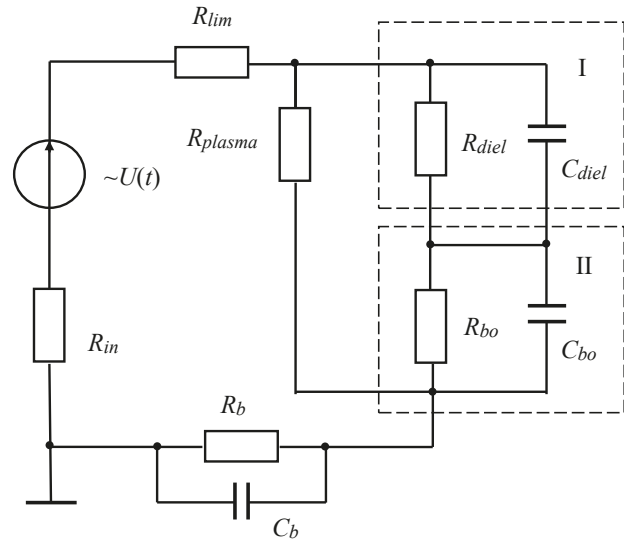

**Fig. 3.** Equivalent circuit for modeling electrical gas-discharge circuits:  
 $R_{in}$  – internal resistance of the voltage source  $U(t)$ ;  $R_{plasma}$  – the resistance to active losses in the discharge plasma;  $R_{diel}$ ,  $C_{diel}$  – resistive-capacitive parameters of the dielectric plate;  $R_{lim}$  – resistor limiting the value of the discharge current;  $R_b$  – the active component of the resistance of the bias current circuit;  $C_b$  – the capacitive component of the bias current circuit;  $R_{bo}$ ,  $C_{bo}$  – resistive-capacitive characteristics of the BO functional state

According to the results of studies carried out in [3], the presence of roughness, dust or moisture on the surface, if they are not associated with a change in surface conductivity, does not affect the image.

The parameters of the second circuit depend on the properties of the skin, the biological object and the intensity of blood flow, and can fluctuate greatly. Based on the analyzes performed [4], it is possible to identify the main information channels for studying BU in the ODS method. They can be conditionally divided into two groups: own or spontaneous and stimulating by an electromagnetic field. Intrinsic include changes in the electrical conductivity or impedance of an object as a whole and its individual parts, structural inhomogeneity of the volume or surface, outgassing and ultra-weak optical radiation. The stimulants include various types of electron emission, optical radiation, and, in the case of water-saturated biostructures, structural inhomogeneity due to displacements of microparticles [21].

It should be noted that in the indicators listed above, the effect of blood flow on the resulting information picture was not mentioned. And since blood vessels are conductors, under the influence of an electric field, an electric current can flow in them, albeit for a short time, which can affect the results obtained. In addition, one cannot ignore the respiratory, digestive, psycho-emotional processes that take place in the body, affecting the composition of the blood, blood pressure, vasodilation, pulse rate, etc. From all of the above, it is possible to conclude that the pulsed discharge current depends on the dynamics of the physiological processes.

The redistribution of current in the circuits presumably occurs due to the displacement of the current. In dielectrics, the displacement current consists of two terms, bias displacement currents in vacuum and polarization currents:

$$j_b = \epsilon_0 \frac{\partial E}{\partial t} + \frac{\partial P}{\partial t}, \quad (2)$$

where  $\epsilon_0 \frac{\partial E}{\partial t}$  – displacement current density in vacuum;  
 $\frac{\partial P}{\partial t}$  – polarization current.

The current due to the ordered movement of bound electric charges in dielectrics or the displacement of charges in non-polar molecules is called the polarization current.

That is, in AC circuits, the full current is always closed. Only the conduction current breaks at the ends of the conductor, and in the dielectrics between the ends of the conductor there is a displacement current that closes the circuit. Since the BO does not touch the conductors during the GDV-gram recording, it can be assumed that the circuit is closed due to bias currents.

The physical processes of closing the circuit between the electrode to which the voltage is applied and the BO have not been thoroughly studied and are practically not described in the literature. Therefore, further studies of these processes are needed.

In the stage of a stationary dynamic discharge (the moment of fixing the image of the glow of the discharge), the effective value of the pulsed displacement current depends on the active resistance of biological tissues and their capacitive properties.

In turn, the active resistance of biological tissues and their capacitive properties depend on physiological processes, blood filling of the vessels of the examined element of the biological object. Thus, the method of gas-discharge visualization uses a pulsed periodic corona sliding discharge with an avalanche-streamer breakdown type in atmospheric air with a single electrode. The voltage of electrical breakdown (the appearance of a glow) depends on:

- 1) the electrophysical properties of the dielectric base with a transparent sputtered electrode (sensor device);
- 2) air pressure, the composition of the gas mixture of air, the presence of microparticles in the air, the concentration of air ions;
- 3) the emission properties of the outer layer of the surface of a biological object;
- 4) the frequency, duration (throughness), polarity of the pulsed current.

In the stage of a stationary dynamic discharge (the moment of fixing the image of the glow of the discharge); the effective value of the pulsed displacement current depends on the active resistance of biological tissues and their capacitive properties.

In turn, the active resistance of biological tissues and their capacitive properties depend on physiological processes, blood filling of the vessels of the examined element of the biological object.

Now it can be noted that the amplitude of the pulsed voltage of the discharge, the frequency of the pulses, the duration and intensity of the pulses, and the polarity act as additional parameters of the process of gas-discharge visualization. Registration of these additional parameters is necessary for correct medical diagnostics based on the results of corona sliding discharge glow.

**6.2. The structure of the device for conducting GDV studies with the registration of additional parameters.** As noted, an algorithm for medical and biological diagnostics based on GDV has become widespread, associated with the distribution of radiation intensity depending on the electrophysical characteristics (physiological state) of biologically active points located in the discharge area. A number of GDV diagnostic devices «GDV Camera», «GDV Compact», «GDV Express» have been developed, made in the form of peripheral equipment for serial PCs, which host software for targeted research [1, 2]. In these devices, a voltage in the form of rectangular pulses with a single intensity with fixed amplitude is used to ensure the occurrence of a discharge. The amplitude of the pulses is chosen to guarantee the «glow» of the object under study.

However, studies of gas discharges that occur in a pulsed electric field prove that the concentration of air ions sufficient for radiation in the visible range of the optical range depends on the amplitude, frequency, and intensity of the pulsed voltage [21–23]. Also, the «glow» spectrum is affected by the electrophysical properties of the object located in the electric field of the discharge [24].

In the case of GDV in medical diagnostics, the object is the patient’s finger phalanges or other biological substances located on the sensor device [13, 21]. For a pulsed gas discharge, the measuring sensor ensures that there is no direct galvanic connection between the object and the high-voltage voltage source. For such an implementation of a sensor device, the integral criterion for the occurrence of a discharge, in addition to glow, is the magnitude of the bias current in the high-voltage power supply circuit.

Thus, additional parameters of the process of gas-discharge visualization, reflecting the electrophysical characteristics of the object under study, can be: the amplitude, frequency, and intensity of the voltage source pulses, determined by the jump in the bias current [24].

The structure of the device that allows determining the listed additional parameters of the GDV diagnostics is shown in Fig. 4.

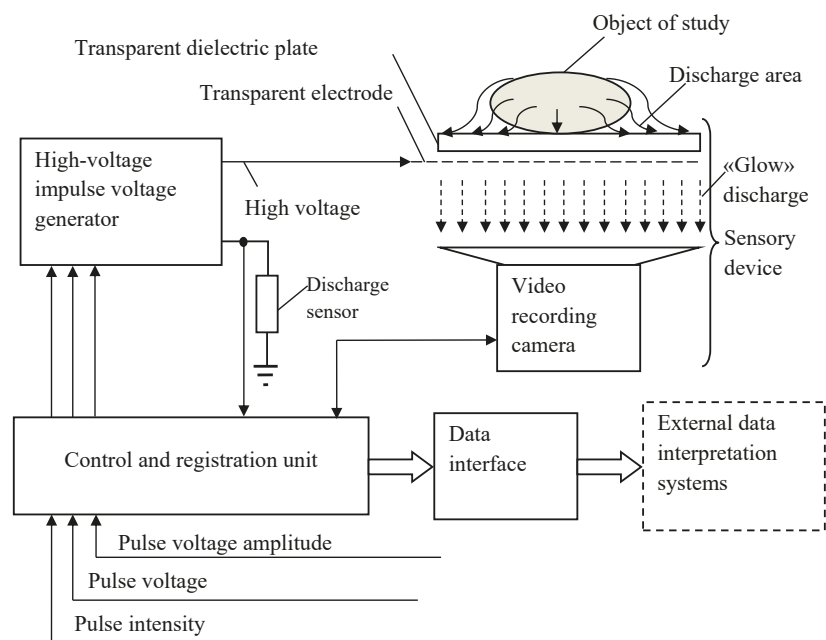

**Fig. 4.** Structural diagram of the building of the GDV procedure with the registration of additional parameters

The advantages of recording the proposed parameters of gas-discharge visualization include quantitative measurement and the possibility of objective comparison. The specified properties of these parameters provide an additional opportunity for a digital description of the state of the object under study, and then automation of the diagnostics.

**6.3. Controlled high-voltage pulsed voltage generator for gas-discharge visualization.** The vast majority of publications devoted to the study of various biological and non-biological objects by the GDV method focus exclusively on the interpretation of images obtained using various modifications of the GDV-camera, Corona-TV, etc. devices [13].

There are practically no publications devoted to the actual circuitry of devices. There are several schemes on the Internet (for example, [25]), but there is no correct description of them. In [4] there is a circuit diagram, but it is completely analog, made on the element base of the late 70s–early 80s of the last century.

One of the areas of work is the creation of the most functional and at the same time easy-to-use and device for gas-discharge visualization of the BU aura. Taking into account the physics of the visualization process, it is possible to conclude that the frequency of high voltage pulses affects the magnitude of the current through the capacitive component of the discharge circuit. At the same time, at high frequencies (tens, hundreds of MHz), the current flows over the surface of the object without penetrating deep into it («skin effect»). Also, the duration of the pulse should be significantly less than the duration of the pause between adjacent pulses – to reduce the time of exposure to a strong electric field on the BO. In addition, to reduce the time of the field impact on the object, it is possible to achieve additional amplitude modulation of the pulse sequence. But in this case, when photographing a GDV image, it is necessary either to synchronize the shutter speed with the modulated signal, or to turn off the modulation altogether. The device must provide high voltage (more than 20 kV) and at the same time be safe to use. Fig. 5 shows the preferred qualitative waveform for successful imaging [7].

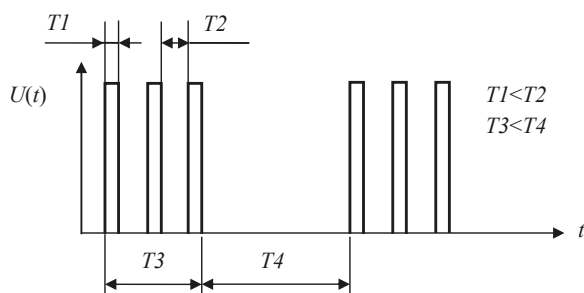

Fig. 5. Pulse sequences of the high voltage generator

Time intervals of impulse voltage:  $T_1$  – pulse duration;  $T_2$  – duration of pause between adjacent impulses;  $T_1+T_2$  – period of the sequence of impulses of the visualization cycle;  $T_3$  – duration of the visualization cycle;  $T_4$  – interval between visualization cycles.

The block diagram of the high-voltage voltage generator unit for GDV diagnostics is shown in Fig. 6.

From the control unit to the high-voltage generator unit, the information input of the microcontroller receives a signal with the values embedded in it:

- voltage amplitudes;
- frequency of the sequence of impulses of the imaging cycle;
- duration and intensity of impulses;
- exposure duration (this data is the settings for the pulse-width modulation (PWM) mode). The microcontroller controls the state of the transistor switch. While it is open, pulses are formed, the amplitude of which is set by a step-up transformer and fed to the electrode of the sensor device. Confirmation of the occurrence of a gas discharge is carried out by a discharge sensor and transmitted to the control unit (Fig. 4).

The proposed structure of the high-voltage generator unit makes it possible to study the regularities of the occurrence of diagnostic luminescence in a wide range of characteristics of impulse voltages with adaptation to the properties of biological structures.

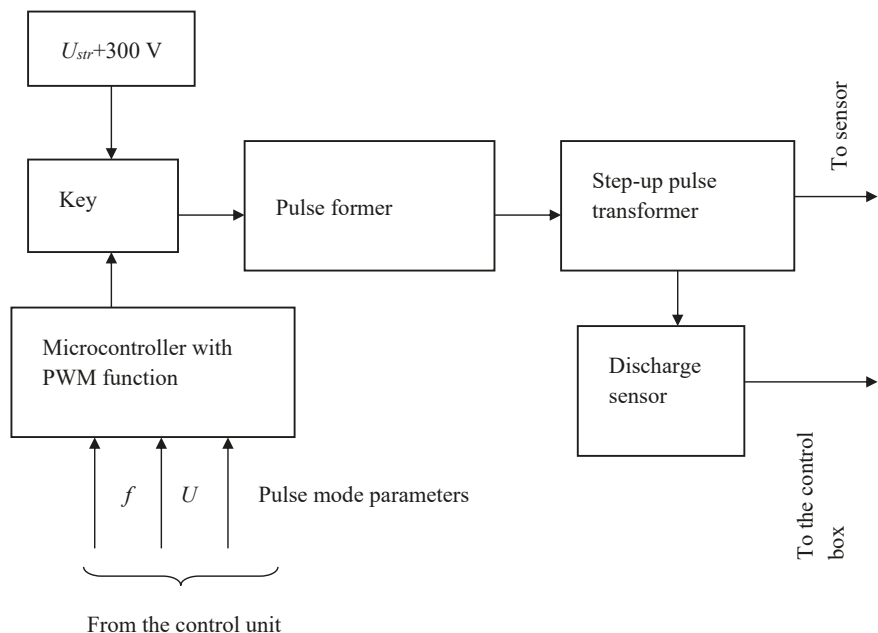

Fig. 6. Structural diagram of the high-voltage generator unit

A step-by-step increase in the amplitude of voltage pulses makes it possible to fix the moment of occurrence of a gas discharge around the BO with a minimum additional energy load on the object itself.

## 7. SWOT analysis of research results

*Strengths.* The conducted research is aimed at developing a new hardware component for GDV medical diagnostics. This partly equalizes the balance between the intensive development of various applications of GDV methods in traditional and alternative medicine with almost unchanged

technical support. It is proposed to register the electrical characteristics of the source of impulse voltages, at which gas-discharge visualization of the biological object of study occurs. These quantitative data are measured directly in the diagnostic process and are related to the general physiological state of a person. They can be used as additional indicators in the analysis of GDV images.

**Weaknesses.** The simulation of the electrical circuit of gas-discharge visualization showed the vulnerability of the discharge conditions to the dielectric characteristics of the sensor elements and their stability. Significant uncertainty is introduced by the complex resistance of the medium to bias currents. Also, the conditions of gas-discharge visualization depend on the concentration of air ions in the ambient air. These factors have a significant impact on the repeatability of the results of GDV diagnostics.

**Opportunities.** The indisputable potential advantage of GDV diagnostics is an integral assessment of the physiological, psycho-emotional, and, as a result, the functional state of a person. The available image processing algorithms are based on the analysis of the intensity distribution of the gas discharge radiation in the recording plane with subsequent computer interpretation. A possible way to increase the information content of GDV images is their spectral analysis within the entire optical spectrum of radiation.

**Threats.** The branch of aviation and space medicine simultaneously requires both the latest computerized methods for diagnosing a person's condition and methods that ensure the reliability of the diagnosis. Regarding the fulfillment of these conditions, the method and means of GDV diagnostics require their improvement. The direction of development of technical solutions is to ensure the dependence of emerging images mainly on the state of the object of study, and not on other factors.

## 8. Conclusions

1. It is shown that to implement the method of gas-discharge visualization, a pulsed periodic corona sliding discharge with an avalanche-streamer type of breakdown in atmospheric air is used. The discharge occurs in a circuit where one of the electrodes is a biological object.

2. The proposed model of electrical circuits of the gas-discharge visualization process. The equivalent circuit consists of resistive and capacitive elements that determine the complex resistance of the gas-discharge sensor and the biostructures under study at the used pulse voltage frequencies.

3. It was revealed that the state of the surface structures placed on the gas-discharge sensor and the electrical impedance of the internal structures of the object under study determine the minimum value of the visualization electrical breakdown voltage. And also that the occurrence of a discharge and the characteristics of the glow depend on the amplitude, duration, intensity, polarity of the pulsed voltage. Registration of additional parameters determines the correctness of further visual diagnostics.

4. Structural diagrams of the device for conducting research using the method of gas-discharge visualization, a block of a high-voltage pulsed voltage generator for hardware accounting for additional parameters of a gas discharge and connection with medical and biological indicators have been developed.

As a result, it should be noted that the use of the method and means of gas-discharge visualization to assess

the functional state of the flight crew before and after the flight period requires the development of special equipment. The proposed technical solutions need experimental verification. Comparative studies of diagnostic findings by RIA with traditional medical diagnostics are necessary.

## Conflict of interest

The authors declare that they have no conflict of interest in relation to this research, whether financial, personal, authorship or otherwise, that could affect the research and its results presented in this paper.

## References

1. Korotkov, K. G. (2001). *Osnovy GRV bioelektrokardiografii*. Saint Petersburg: SPbGITMO, 354.
2. Korotkov, K. G. (2007). *Printsipy analiza v GRV Bioelektrografii*. Saint Petersburg: Renome, 286.
3. Korotkov, K. G., Matravets, P., Orlov, D. V., Williams, B. O. (2010). Application of Electrophoton Capture (EPC) Analysis Based on Gas Discharge Visualization (GDV) Technique in Medicine: A Systematic Review. *The Journal of Alternative and Complementary Medicine*, 16 (1), 13–25. doi: <http://doi.org/10.1089/acm.2008.0285>
4. Korotkov, K. G. (1982). *Issledovanie fizicheskikh protsessov, protekaiushchikh pri gazorazriadnoi vizualizatsii razlichnykh obektov*. Leningrad, 227.
5. Bista, S., Jasti, N., Bhargav, H., Sinha, S., Gupta, S., Ramarao, P., Chaturvedi, S. K., Gangadhar, B. N. (2022). *Applications of Gas Discharge Visualization Imaging in Health and Disease: A Systematic Review*. *Alternative Therapies in Health and Medicine*.
6. Grozdeva, D., Dikova, T. (2018). Gas discharge visualization – historical developments, research dynamics and innovative applications. *Scripta Scientifica Salutis Publicae*, 4, 27–33. doi: <http://doi.org/10.14748/sss.v4i0.5448>
7. Kolomiets, R. O. (2005). Zahalni pryntsyipy doslidzhennia biolichnykh ob'ektiv za dopomohoiu metodu hazorozriadnoi vizualizatsii. *Visnyk ZhDTU Seriya – Tekhnichni nauky*, 4 (35), 61–67.
8. Korotkov, K. G. et al. (2012). Pat. No.: US 8,321,010 B2. *Method for Determining the Condition of a Biological Object and Device for Making Same*. Published: 27.10.2012. Available at: <https://patentimages.storage.googleapis.com/6c/4c/11/795f70f41649f8/US8321010.pdf>
9. Korotkov, K. H., Yusubov, R. R.-O. (2011). Sposob opredeleniya sostoianiya byolohyeheskoho ob'ekta y ustroystvo dlia eho realizatsyy. *Vsemymaia Orhanyzatsyia Yntellektualnoi Sobstvennosti. Nomer mezhdunarodnoi publikatsyy* WO2011/028146 A1.
10. Korotkov, K. G., Korotkina, S. A., Jusubov, R. R.-O. (2010). Pat. No. US 2010/0106424 A1. *Device for determining the state of a biological subject*. Published: 29.04.2010. Available at: <https://patents.justia.com/patent/20100106424>
11. Chehnev, V. L., Chehneva, L. V., Mynaiilo, V. N., Sosnovskiy, M. S. (2018). *Sposob rezonansno-volnovoho testyrovannya sostoianiya orhanov y system*. Evrazyskoe patentnoe vedomstvo EA029691B1. Declared: 29.08.2011; published: 30.04.2018.
12. Kukhtyn, V. V., Petelskyi, P. V., Chepurnyi, Yu. V. (2010). Aparatna realizatsiia i diahnostychni mozhlyvosti metodu hazorozriadnoi vizualizatsii. *Visnyk Natsionalnoho tekhnichnogo universytetu Ukrainy «KPI»*, 143 Seriya – Radiotekhnika. *Radioaparatobuduvannia*, 42, 139–144.
13. Korotkov, K. G., Matravets, P., Orlov, D. V., Williams, B. O. (2010). Application of electrophoton capture (EPC) analysis based on gas discharge visualization (GDV) technique in medicine: a systematic review. *Journal of Alternative and Complementary Medicine*, 16 (1), 13–25. doi: <http://doi.org/10.1089/acm.2008.0285>
14. Kostyuk, N., Cole, P., Meghanathan, N., Isokpehi, R. D., Cohly, H. H. P. (2011). Gas Discharge Visualization: An Imaging and Modeling Tool for Medical Biometrics. *International Journal of Biomedical Imaging*, 2011, 1–7. doi: <http://doi.org/10.1155/2011/196460>



15. Babelyuk, V., Dobrovolskiy, Y., Pidkamin, L., Popovych, I., Ushenko, Y. (2020). Usage of a gas-discharge visualization for an investigation of a human internal energy. *Fourteenth International Conference on Correlation Optics*. doi: <http://doi.org/10.1117/12.2553951>
16. Babelyuk, V., Tserkovniuk, R., Babelyuk, N., Zukow, X., Ruzhylo, S., Dubkova, G. et. al. (2021). The parameters of gas discharge visualization (biophotonics) correlated with parameters of acupuncture points, EEG, HRV and hormones. *Journal of Education, Health and Sport*, 11 (12), 359–373. doi: <http://doi.org/10.12775/jehs.2021.11.12.030>
17. Kosulina, N. H., Cherenkov, O. D., Kuchyn, L. F., Sverhun, Yu. F. (2006). Pat. No. 18211 UA. *Prystrii dlia fotohrafuvannia ta obstezhennia biolohichnykh ob'ektiv na osnovi efektu Kirlian*. MPK (2006) G03B41/00. No. a 2005 11572; declared: 05.12.2005; published: 15.11.2006, Bul. No. 11, 4.
18. Kozharin, V. V., Zatsepin, M. M., Domorod, N. Ye. (1986). *Elektrozriadnyi metod vizualizatsii*. Minsk, 134.
19. Pavliuk, O. A. (2015). *Metod i zasib hazorozriadnoi vizualizatsii dlia analizu ridynnofaznykh bioob'ektiv*. Vinnytsia, 240.
20. Aronov, M. A. (1969). *Elektricheskie razriady v vozdukhe pri napriazhenii vysokoi chastoty*. Moscow: Energiia, 175.
21. Bilynskyi, Y. Y., Pavliuk, O. A. (2016). *Metody i zasoby hazorozriadnoi vizualizatsii dlia analizu ridynnofaznykh bioob'ektiv*. Vinnytsia: VNTU, 120.
22. Kadomtceva, B. B. (Ed.) (1989). *Voprosy teorii plazmy*. Moscow: Energoatomizdat, 248.
23. Raizer, Iu. P. (2009). *Fizika gazovogo razriada*. Dolgoprudnyi: Intellekt, 725.
24. Oliinyk, V. P., Babushenko, S. S. (2020). Vybir dodatkovykh parametriv protsesu hazorozriadnoi vizualizatsii dlia zastovuvannia v medychnii diahnostytsi. *Informatsiini systemy ta tekhnolohii v medytsyni» (ISM–2020)*. Kharkiv: Nats. aerokosm. un-t im. M. Ye. Zhukovskoho «Kharkiv. aviats. in-t», 195–197.
25. *Hazorozriadnaia vizualizatsiia ustroistva skhemy*. Available at: <https://www.google.com/search?client=firefox-b-d&q=Гаазорозрядная+визуализация+устройства+схемы#imgsrc=p0-1qlsqYztxM>

✉ **Volodymyr Oliinyk**, PhD, Professor of Department of Electronic and Biomedical Computerized Means and Technologies, National Aerospace University «Kharkiv Aviation Institute», Kharkiv, Ukraine, e-mail: [v.oliinyk@khai.edu](mailto:v.oliinyk@khai.edu), ORCID: <https://orcid.org/0000-0002-7899-1591>

✉ **Mykhailo Babakov**, PhD, Professor, Department of Electronic and Biomedical Computerized Means and Technologies, National Aerospace University «Kharkiv Aviation Institute», Kharkiv, Ukraine, ORCID: <https://orcid.org/0000-0001-8642-3693>

✉ **Yurii Lomonosov**, PhD, Associate Professor, Department of Electronic and Biomedical Computerized Means and Technologies, National Aerospace University «Kharkiv Aviation Institute», Kharkiv, Ukraine, ORCID: <https://orcid.org/0000-0002-6115-6194>

✉ **Viacheslav Oliinyk**, PhD, Associate Professor, Department of Electronic and Biomedical Computerized Means and Technologies, National Aerospace University «Kharkiv Aviation Institute», Kharkiv, Ukraine, ORCID: <https://orcid.org/0000-0001-7443-3720>

✉ **Oleksandr Zinchenko**, Assistant, Department of Electronic and Biomedical Computerized Means and Technologies, National Aerospace University «Kharkiv Aviation Institute», Kharkiv, Ukraine, ORCID: <https://orcid.org/0000-0001-5651-8931>

✉ *Corresponding author*